

OWNER'S MANUAL



You can rely on Defy. To simplify

CERAN-SMOOTH TOP HOBS

- 2 Introduction.
- 2 Unpacking.
- 2 Know your product
- 2 Cupboard design.
- 3 Aperture sizes
- 4 Installation
- 5 Safety installation for hobs with a control panel**
- 6 Electrical installation
- 6 The controls
- 7 Ceran smooth top.
- 8 Technical specifications.
- 9 Safety advice**
- 9 Problem check.
- 9 Owner's responsibility.
- 10 Defy Service Centres.
- 11 Warranty.
- 12 Purchase details to be filled in

Part Number 067912

Please register your product at
www.defy.co.za

Introduction

Congratulations on the purchase of this quality hob

We, the manufacturer, trust that you will enjoy many years of trouble free use.

Please read these instructions carefully before using the hob.

This book will provide you with information on how to operate and care for your hob in order that you gain the maximum benefit from it.

Unpacking

- Please ensure that packaging material is disposed of in a responsible manner.
- Plastic bags should be cut up to prevent children playing with them and accidentally suffocating.
- Some models feature a protective film over stainless steel trim. This film must be carefully removed before using the hob.
- If the appliance is damaged in any way, do not use it. Report the damage to your dealer, who will take the necessary corrective action.

Know your product

Defy Ceran hobs are available in two model sizes and two configurations.

- **Gemini 700 CP** model **with** a control panel
- **Gemini 700 NCP** model **without** a control panel

- **Slimline 600 CP** model **with** a control panel
- **Slimline 600 NCP** model **without** a control panel

- **Hobs with control panels** may be used on their own or with an eye-level oven.
- **Hobs without control panels** may only be used when connected to a Defy under-counter oven. The hob controls in this instance, are located on the oven fascia.

Please determine the type of hob you have purchased and read only the instructions pertaining to that model.

Cupboard design

- Cooking appliances generate considerable heat. The layout and materials of the mounting cabinet should take account of these characteristics.
- Surfaces and surrounding edges immediately adjacent to the hob should be able to withstand temperatures of up to 100°C without delaminating or discolouring.

Aperture sizes

Gemini 700 models

WITH A CONTROL PANEL

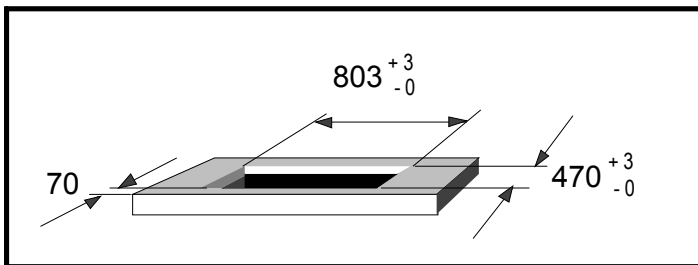

WITHOUT A CONTROL PANEL

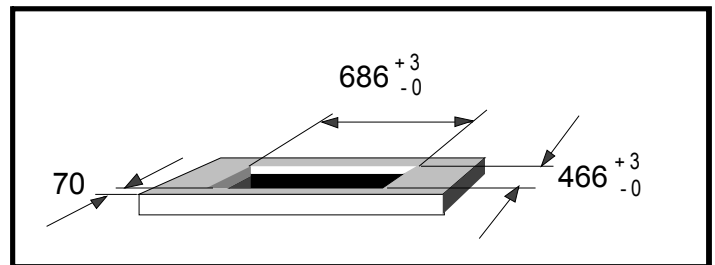

Slimline 600 models

WITH A CONTROL PANEL

WITHOUT A CONTROL PANEL

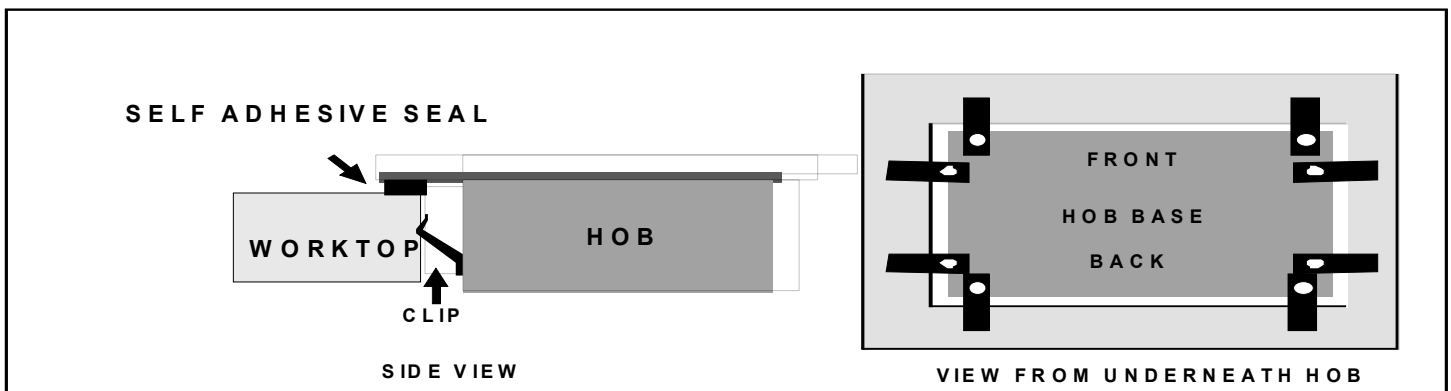

Installation

Installation is the buyer's responsibility. The manufacturer accepts no liability for this service. Any action that the manufacturer has to take as a result of an erroneous installation will not be covered by the warranty.

- The hob is supplied with 8 securing clips.
- These fit into 8 dedicated slots around the hob base . (see picture A)
- Insert the clips (as shown in picture B)
- Lift the clips up until they click into place. (as shown in picture C)

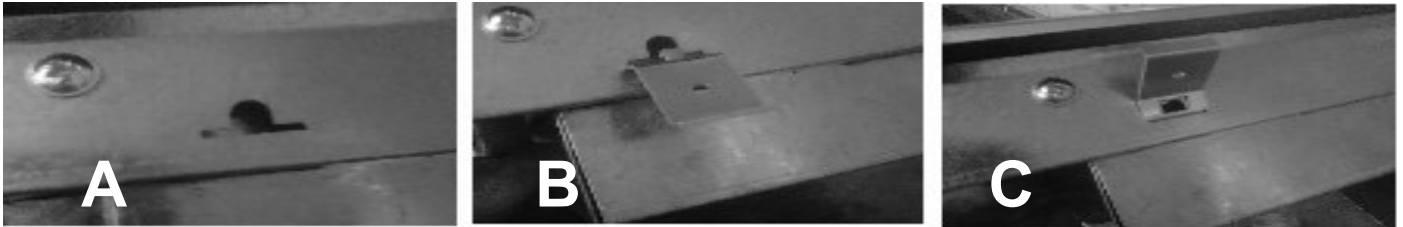

- To avoid liquid spills penetrating between the hob and the worktop, apply the supplied self-adhesive seal to the perimeter of the aperture. Do not use a silicone sealer.
- Invert the hob on the worktop adjacent to the aperture before making the electrical connection. This will ensure sufficient cable length for subsequent servicing.
- Position the hob into the aperture so that the securing clips are compressed between the hob base and the worktop. (see Sketch below)

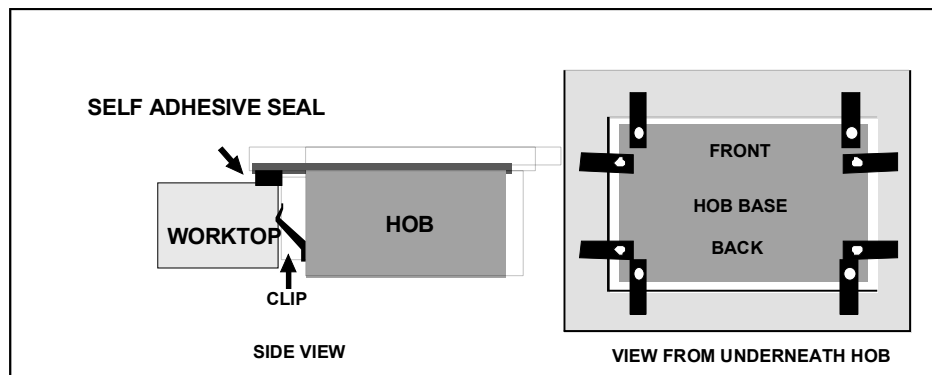

Important notice

- Hobs without control panels should be installed directly above the oven.
- Hobs with control panels require additional installation instructions. See page 5.



VERY IMPORTANT SAFETY INSTRUCTION

Safety installation for hobs with control panels only

- A removable horizontal board must be fitted below the hob and 75mm away from the work-top bottom face.
- Space between this board and the hob must be empty and no objects may be stored or kept there.
- This board will effectively shield the user from the base of the hob which gets hot during use. The board needs to be removable for service purposes as the hob, once installed, can only be loosened from below.
- If the hob is installed with a side adjacent to a vertical kitchen cabinet, the distance between the edge of the hob and that of the cabinet side must be a least 150mm. The distance between the back wall and the rear edge of the hob must be at least 55mm.

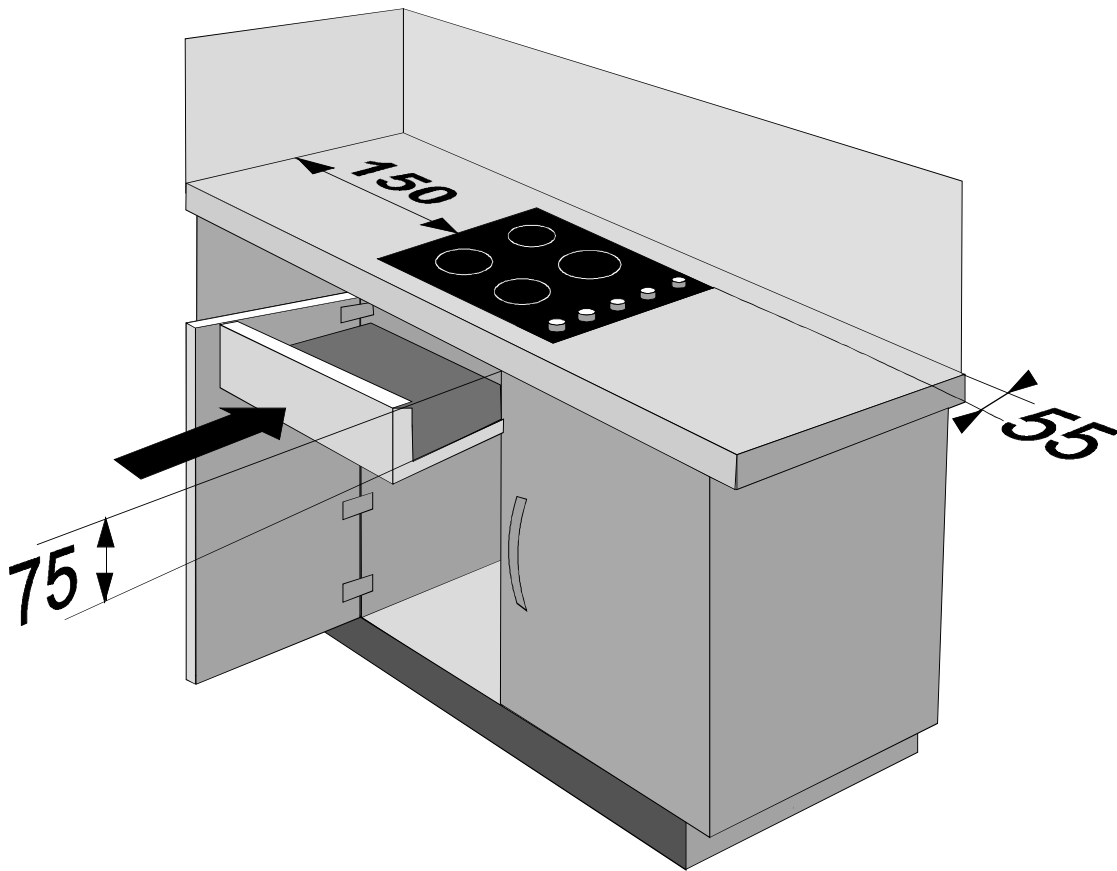

Electrical installation

This appliance must be earthed and the manufacturer and the seller do not accept responsibility for any damage due to incorrect installation or electrical connection.

Hobs with control panels

Earth leakage

This hob should not be connected through an earth leakage system.

Refer to S.A.B.S. 0142

Connection to the power supply must be carried out by a licensed electrician, who will ensure that the hob is correctly connected and safely earthed. The rated current is printed on the serial number label attached to the base cover.

The hob must be connected to the mains through a double pole isolating switch which has a minimum clearance between the contacts of 3 mm. in both poles.

A means for disconnection must be provided in the fixed wiring.

Note:

The appliance is not intended to be operated by means of an external timer or separate remote-control system.

Hobs without control panels

Electrical connection is via connector blocks to the oven below the hob.

Please see the section pertaining to electrical connection as described in the oven manual.

Controls . The plate controls for hobs without a control panel are located on the oven fascia

Plate controls

1. Left front
2. Left back
3. Right back
4. Right front

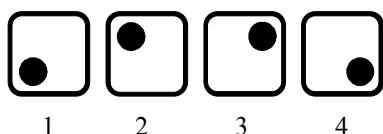

Hot surface indicator

Individual light for each plate.

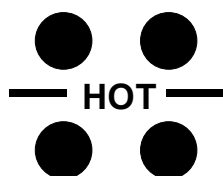

Dual Zone plate control on Gemini CP model only



INNER ZONE

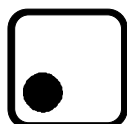

INNER & OUTER ZONE

Ringer timer

on Gemini CP model only



- The ringer timer may be used for timing a cooking period of up to 60 minutes.
- First wind the timer by turning the knob fully clockwise.
- Return the knob to the desired time period.
- At the end of this period the bell will ring.
- Note: If the timer is not first fully wound the bell may not ring.

Ceran® smooth top

WARNING In the unlikely event of the Ceran sustaining accidental damage or cracks, switch off the appliance at the mains to avoid electric shock and have the panel replaced before further use.

Plate controls

- Select the heat level by turning the relevant plate control knob to the required setting. The higher the number selected, the hotter the temperature of the plate will be.
- The plate indicator light will glow when the plate is switched on. Shortly thereafter the hot surface indicator light on the hob will switch on and will remain on for 20 to 30 minutes after the plate is switched off.. This is a reminder that the hob surface is still too hot to touch.
- **Some models feature a dual zone plate. Turning the control knob to the left, activates the inner zone and turning it to the right activates both the inner and outer zones.**

Caring for the Ceran hob

- Ceran is a tough, durable material, which provides a beautiful, functional and long lasting cooking surface. To keep it looking good, it needs to be treated with care and cleaned regularly.
- Spillage should be wiped off as soon as possible with a damp cloth, preferably while the hob is still warm.
- Clean the hob with a nylon pad and ‘Smooth top cleaner’. A sample of this cleaner is supplied with the unit. Replenishment cleaner is available from all Defy Service Centres.
- If necessary stubborn spills may be removed using the blade scraper provided.
- Do not use metal scourers or coarse abrasive powders as these could scratch the Ceran.
- Regular cleaning after use will prevent dirt build up and ensure that the hob remains bright and attractive.
- Wipe the hob surround with a damp hot soapy cloth and dry.
- **DO NOT USE A STEAM CLEANER.**

Recommendations (see also the enclosed ‘CERAN’ leaflet)

- Use only pots with a solid level base. An uneven base will prolong cooking time and waste energy.
- Use pots with a base diameter slightly larger than that of the thermal area. This will ensure even heat distribution and prevent spillage from dripping onto and staining the hot zone.
- Always cover the pot with a lid. This will conserve energy and minimize spillage.
- Save energy by switching the plate off 5 to 10 minutes before the end of a lengthy cooking period. The Ceran hob will retain sufficient residual heat to complete the cooking process.
- A pot with rough edges could scratch the Ceran if it were dragged across the surface of the hob.
- Any spillage of sugar solution such as jam, must be removed immediately. If allowed to cool on the Ceran it could pit and damage the surface.
- Do not cover the Ceran with aluminium foil and do not use poor quality aluminium pots. These will leave unsightly deposits which in time, could adhere to the Ceran.

Technical Specifications

Model	GEMINI CERAN	SLIMLINE CERAN HOB
Volts	230V –250V 50Hz~	230V –250V 50Hz~
Amperes	29	29
Plate power rating (W)		
Large plate front	2100 (2200-750 dual)	2100
Small plate front	1200	1200
Small plate back	1200	1200
Large plate back	2100	2100
For hobs with control panels		
Integrated	Yes	Yes
6 Heat switches	3	4
Energy reg. Dual zone	1	
Hot surface indicator	Yes	Yes
Indicator lights	4	Yes
60 minute ringer timer	1	No
Options		
Stainless frame	Yes	Yes
Frameless	Yes	Yes

The Manufacturer strives for continuous improvements. For this reason, the text and illustrations in this book are subject to change without notice.

Safety advice

- This appliance is not intended for use by persons (including children) with reduced physical, sensory or mental capabilities, or lack of experience and knowledge, unless they have been given supervision or instruction concerning use of the appliance by a person responsible for their safety.
- Children should be supervised to ensure that they do not play with the appliance.
- Only use the appliance for preparing food.
- Do not leave hot fat or oil unattended. If overheating occurs, these could catch fire.
- Switch off the power at the mains in the event of a fault or when cleaning the appliance.

Problem check

Before calling a service technician to assist with a problem,

PROBLEM

SOLUTION

The plates do not work

Check there is power to the wall switch.

The timer on Gemini hobs make a clicking noise

This is normal. Timers do make a clicking noise.

Remember that you may be charged for a service call even during the warranty period if the fault is due to or caused by any of the above.

Owner's responsibility

Since the following are not factory faults, they are the owner's responsibility.

- Damage to exterior finish.
- Breakage of glass and other components.
- Damage through improper use or installation of the appliance.
- Damage caused by moving the appliance.
- Rusted or corroded solid plates.

Did you remember To fill in the purchase details on page 12 of this manual.

Defy Service Centres

If you have followed the instructions and still have a problem, contact the nearest Defy Technical Support Centre. They will be able to advise you on any aspect of the product or send a qualified technician to repair it.

BLOEMFONTEIN 160 Long Street, Hilton,
Bloemfontein 9301.
Tel. 051 400 3900
Bloemfontein.Service@defy.co.za

CAPE TOWN 5A Marconi Rd.
Montague Gardens, 7441.
Tel. 021 526 3000
CapeTown.Service@defy.co.za

DURBAN 35 Intersite Avenue,
Umgeni Business Park, Durban 4051.
Tel. 031 268 3300
Durban.Service@defy.co.za

EAST LONDON 16 Bowls Rd. Arcadia,
East London 5201.
Tel. 043 743 7100
EastLondon.Service@defy.co.za

JOHANNESBURG Cnr. Mimetes & Kruger Sts. Denver ext.12
Commercial Head Office,
Administration, Distribution, National Groups,
Tel. Sales, Contracts and Credit.
Johannesburg. 2094.
Tel. 011 621 0200 or 011 621 0300
Gauteng.Service@defy.co.za

POLOKWANE 87 Nelson Mandela Drive.
Superbia 0699.
Tel. 0152 92 1166 / 7 / 8 / 9.
Polokwane.Service@defy.co.za

PORT ELIZABETH 112 Patterson Road,
North End, Port Elizabeth 6001.
Tel. 041 401 6400
PortElizabeth.Service@defy.co.za

PRETORIA. Block A1 Old Mutual Industrial Park.
Cnr. D.F.Malan Drive & Moot Str.
Hermanstad. 0082.

**OTHER AREAS ARE SERVICED BY OVER 200 AUTHORISED AGENTS.
FOR FURTHER DETAILS PLEASE CONSULT THE NEAREST REGIONAL**

Warranty

This certificate is issued by DEFY APPLIANCES (PTY) LTD manufacturers of Defy and Ocean products, hereinafter the Company, to the original purchaser only, of the appliance described on the certificate and shall constitute the only warranty given in respect of this appliance.

The Company warrants to the original purchaser that for a period of TWO YEARS from date of purchase the appliance is free from defect under normal domestic use, both in workmanship and material, subject to the following conditions.

1. Repair or replacement of any part of this appliance, found by the Company to be defective, shall be at the election of the Company. The Company reserves the right to effect such service through any of its Service Divisions or Authorised Service Dealers. The cost of such service shall be borne by the Company in full, provided that the appliance is located no further than 50 km from a Company Service Centre or an Authorised Service Dealer. Where the appliance is located beyond the 50 km radius, the purchaser shall be liable for the standard travelling charges, as determined by the Company.
CARRY IN SERVICE Microwave ovens, Compact cookers and small appliances are repaired in our service centres and are not collected from the customers home. Faulty units should be delivered to the purchasing dealer or to the nearest Company Service Centre for warranty repairs.
2. Rusted or corroded plates, vitreous enamelware, fuses and lamps are specifically excluded from these warranties. It is an express condition of these warranties that the purchaser takes due care and attention in the use and maintenance of the appliance. Abuse, misuse in conflict with operating instructions, connection to incorrect voltages and subjection to commercial use shall release the Company from its obligations.
3. This warranty shall become void and cease to operate if the appliance is dismantled by, or any repairs to the appliance are effected by any persons not duly authorised by the Company, or if substitute parts not approved by the Company are used in the appliance, or if the serial number of the appliance is removed.
4. The Company shall not be responsible for damages resulting from fire, flood, civil disturbances or any Act of God. The Company shall not, in terms of these warranties be responsible nor held liable for any consequential loss or damage of any kind caused by or due to the failure or malfunction of the appliance.
5. The Company shall not be responsible for transportation or other costs other than those incurred within the provisions of Point 1 of this Certificate.
6. These warranties shall not apply to the appliance if it is purchased or used beyond the borders of the Republic of South Africa, Namibia, Botswana, Swaziland and Lesotho.
7. Where service is requested under warranty and no fault or defect can be found by the Company, all costs incurred will be for the purchaser's account.
8. This Certificate as well as your invoice will serve as proof of purchase. For the purpose of warranty, it will be essential to produce this Certificate and invoice. Failure to do so, will render the purchaser liable for service costs.

KEEP THIS CERTIFICATE AND SALES INVOICE AS PROOF OF PURCHASE FOR WARRANTY PURPOSES.



You can rely on Defy. To simplify

For future reference, record the listed information in the space below.
The Serial number may be found on the label attached to the hob base.

Serial No:

Date of purchase:

Purchased from:
