

**OWNER'S MANUAL  
TWINMAID 800  
DTT166**



You can rely on Defy. To simplify

Please register your  
product at  
[www.defy.co.za](http://www.defy.co.za)

<b>INDEX</b>	<b>PAGE</b>
<b>GET TO KNOW YOUR MACHINE</b>	<b>3</b>
<b>INSTALLATION</b>	<b>4</b>
<b>SAFETY PRECAUTIONS</b>	<b>5</b>
<b>WASHING</b>	<b>6 / 7</b>
<b>DRAINING</b>	<b>8</b>
<b>RINSING</b>	<b>9 / 11</b>
<b>SPIN DRYING</b>	<b>12</b>
<b>AFTER USE</b>	<b>13</b>
<b>MAINTENANCE</b>	<b>14</b>
<b>CLEANING THE DRAIN FILTER</b>	<b>15</b>
<b>HELP</b>	<b>16</b>
<b>DEFY SERVICE CENTRES</b>	<b>17</b>
<b>WARRANTY</b>	<b>18</b>
<b>CIRCUIT DIAGRAM</b>	<b>19</b>
<b>SPECIFICATIONS</b>	<b>19</b>
<b>PURCHASE INFORMATION</b>	<b>20</b>

## Get to know your Machine

**Note: This machine is for domestic use only.**

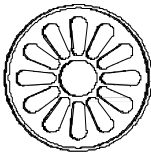
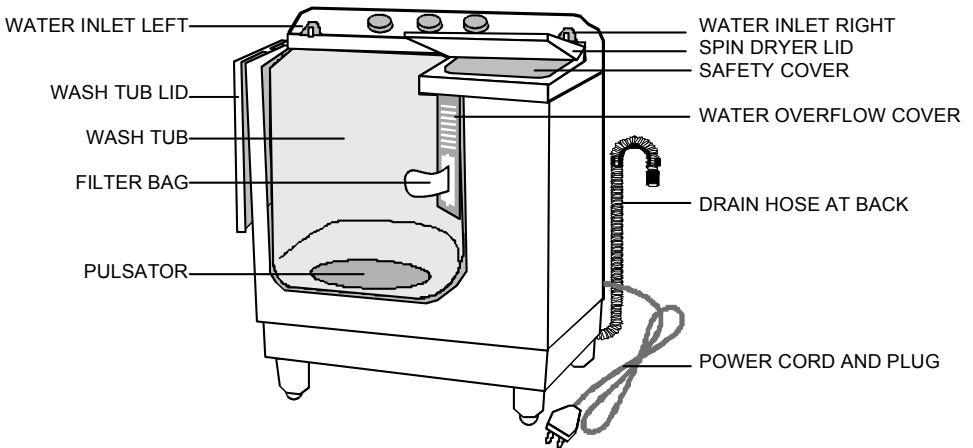
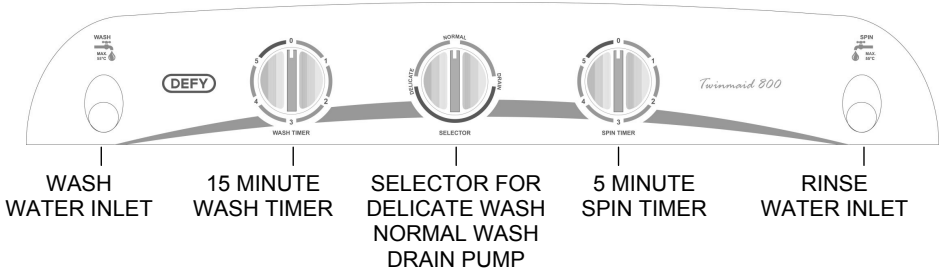

SPIN TUB LID COVER



WATER SUPPLY HOSE



DRAIN HOSE AND CLAMP

# INSTALLATION

**1** DO NOT STAND THE MACHINE WHERE IT IS EXPOSED TO DIRECT SUNLIGHT OR RAIN

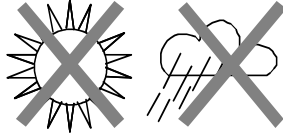

**2** CONNECT THE INLET HOSE TO THE WATER TAP AND TO THE MACHINE.

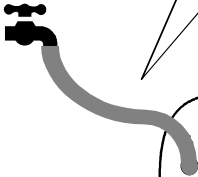

**3** PUSH THE 3 PIN PLUG INTO A 15A. EARTHED WALL SOCKET.

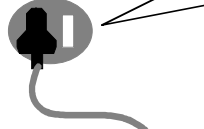

**WARNING**  
THIS APPLIANCE MUST BE EARTHED

**4** TURN THE TIMER CONTROL KNOBS TO "0"

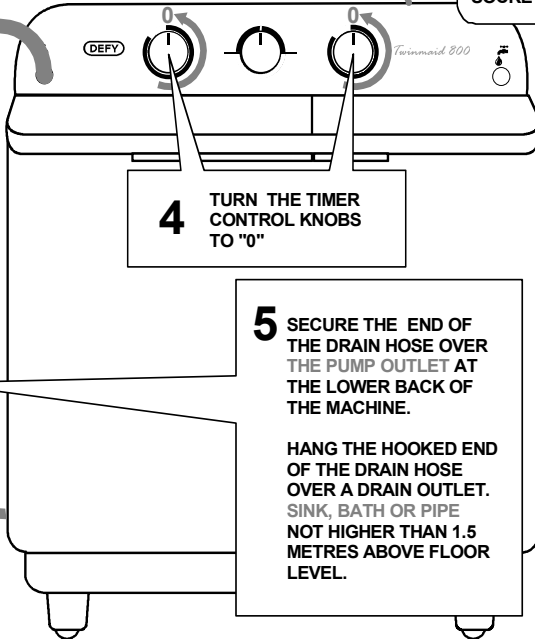

**5** SECURE THE END OF THE DRAIN HOSE OVER THE PUMP OUTLET AT THE LOWER BACK OF THE MACHINE.

HANG THE HOOKED END OF THE DRAIN HOSE OVER A DRAIN OUTLET. SINK, BATH OR PIPE NOT HIGHER THAN 1.5 METRES ABOVE FLOOR LEVEL.

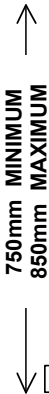

**THE MACHINE MUST STAND ON A LEVEL SURFACE**

# SAFETY PRECAUTIONS

This appliance is not intended for use by persons (including children) with reduced physical, sensory or mental capabilities, or lack of experience and knowledge, unless they have been given supervision or instruction concerning use of the appliance by a person responsible for their safety.

Children should be supervised to ensure that they do not play with the appliance.

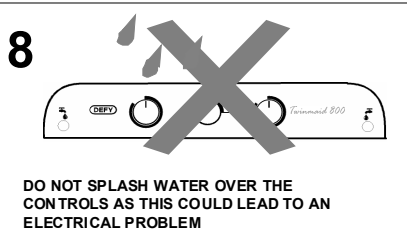
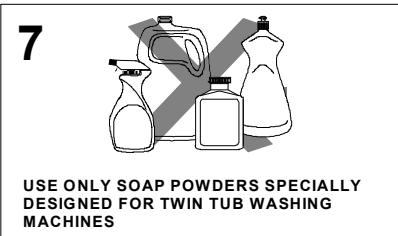
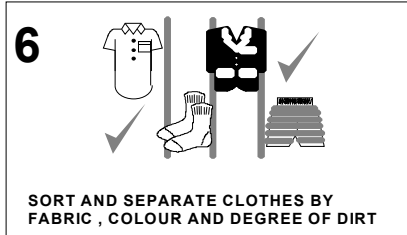
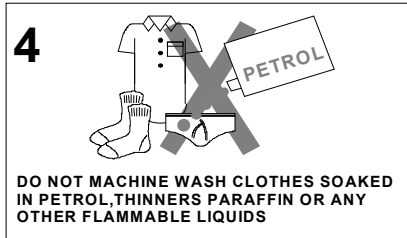
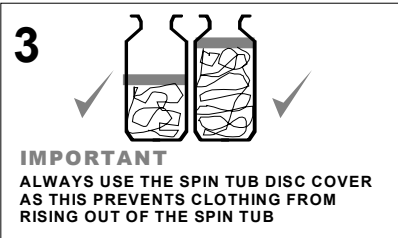
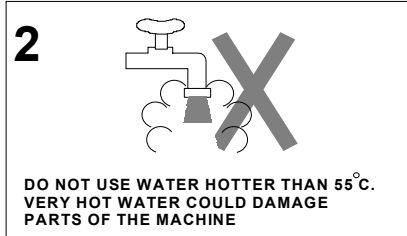

**IMPORTANT**  
**NEVER TRY TO TURN A KNOB FURTHER THAN THE MARKING ON THE DIAL**  
**TURN ANTI CLOCKWISE TO RETURN THE KNOB TO "0"**

# WASHING

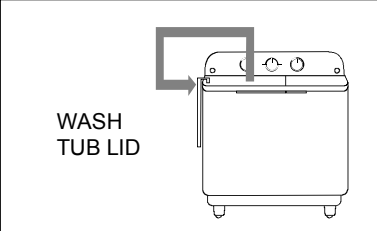

WASH TUB LID

**1** REMOVE WASH TUB LID AND HANG IT ON THE SIDE OF THE MACHINE

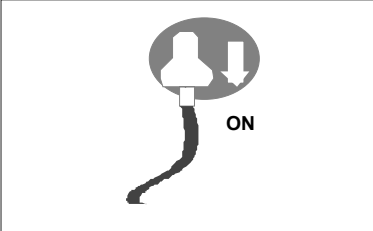

**2** SWITCH ON THE POWER AT THE WALL SOCKET



**3** TURN THE SELECTOR KNOB TO GENTLE OR NORMAL WASH

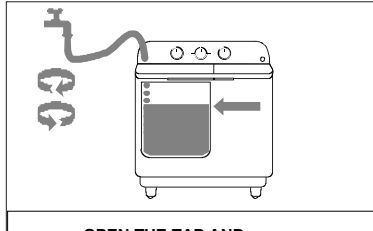

**4** OPEN THE TAP AND FILL THE WASH TUB WITH WATER TO THE DESIRED LEVEL THEN CLOSE THE TAP



**5** ADD SOAP POWDER AS DIRECTED. USE ONLY DETERGENT DESIGNED FOR TWIN TUB WASHING MACHINES.



**6** PLACE THE WASHING IN THE TUB ONE ARTICLE AT A TIME

# WASHING CONTINUED

7

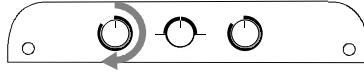

TURN THE WASH TIMER KNOB TO THE DESIRED TIME

WASH	FABRIC	TIME	MAX. DRY LOAD
GENTLE	SYNTHETICS, WOOL, SILK	2 TO 5 MINUTES	2.0 kg
NORMAL	COTTON, LINEN	5 TO 10 MINUTES	3.5 kg
NORMAL	VERY DIRTY WASHING	9 TO 15 MINUTES	5.0 kg

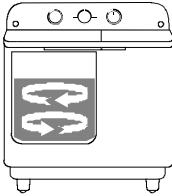

8

THE WASHING MACHINE WILL START WASHING AS PER THE SELECTED TIME AND WASH PROGRAMME

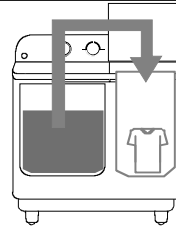

9

AFTER THE WASHING IS COMPLETE, REMOVE THE WASHING FROM THE WASH TUB AND PLACE IT IN THE SPIN DRUM

**WARNING**

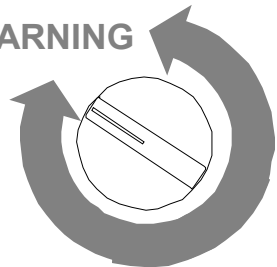

IMPORTANT  
NEVER TURN A KNOB  
FURTHER THAN THE MARKING ON THE DIAL  
TURN ANTI CLOCKWISE TO RETURN TO "0"

# DRAINING



**10**

IF REQUIRED, ANOTHER LOAD MAY BE WASHED IN THE SAME SOAPY WATER. IF NOT, THE MODE SELECTOR KNOB SHOULD BE TURNED TO DRAIN

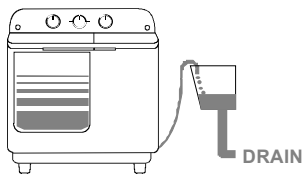

**11** THE SOAPY WATER WILL DRAIN FROM THE MACHINE

## IMPORTANT



**12**

AFTER ALL THE WATER HAS DRAINED. THE SELECTOR MUST BE RETURNED TO THE WASH / RINSE MODE. FAILURE TO DO SO WILL ALLOW THE PUMP TO CONTINUE RUNNING AND MAY CREATE AN AIR LOCK WHICH WILL PROHIBIT EFFECTIVE DRAINING. IF THE DRAIN MODE HAS BEEN SELECTED AND THE MACHINE DOES NOT DRAIN, IT IS PROBABLE THAT AN AIR LOCK HAS OCCURRED. TO CLEAR THE AIR LOCK, THE SELECTOR SHOULD BE TURNED TO THE WASH MODE FOR ABOUT 5 SECONDS BEFORE RETURNING IT TO THE DRAIN POSITION.

## WARNING

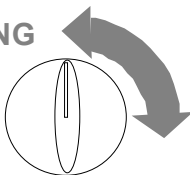

IMPORTANT  
NEVER TURN A KNOB  
FURTHER THAN THE MARKING ON THE DIAL  
TURN ANTI CLOCKWISE TO RETURN TO "0"



# RINSING

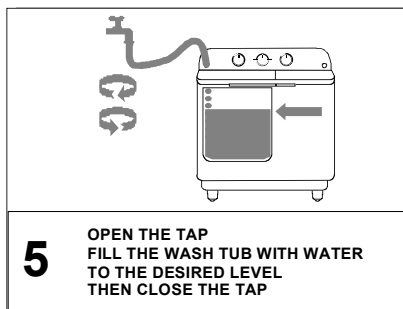
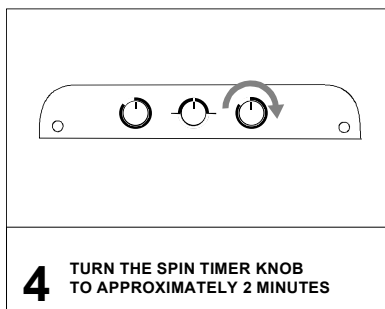
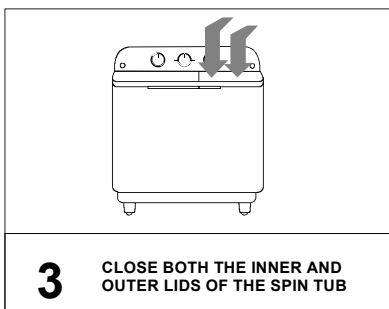
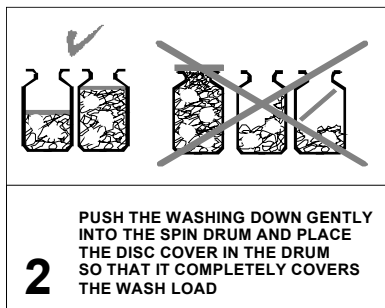

# RINSING CONTINUED



NORMAL

**7** TURN THE SELECTOR KNOB TO NORMAL



**8** TURN THE WASH TIMER KNOB TO THE REQUIRED TIME FOR RINSING.

NORMAL RINSE	- SYNTHETICS, WOOL, SILK	2-5 MIN
NORMAL RINSE	- COTTON, LINEN	5-15 MIN
HEAVY RINSE	- HEAVY ROBUST FABRICS	9-15 MIN

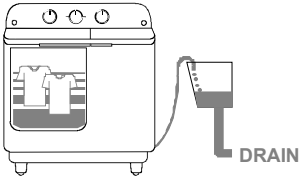
**9** AFTER RINSING TURN THE MODE SELECTOR TO DRAIN THIS WILL DRAIN OFF THE RINSE WATER

**10** *IMPORTANT*



YOU MAY WISH TO REPEAT STEPS 6 TO 9 UNTIL YOU ARE SATISFIED THAT THE WASHING HAS BEEN PROPERLY RINSED.

AFTER ALL THE WATER HAS DRAINED. THE SELECTOR MUST BE RETURNED TO THE WASH / RINSE MODE FAILURE TO DO SO WILL ALLOW THE PUMP TO CONTINUE RUNNING AND MAY CREATE AN AIR LOCK WHICH WILL PROHIBIT EFFECTIVE DRAINING.

IF THE DRAIN MODE HAS BEEN SELECTED AND THE MACHINE DOES NOT DRAIN, IT IS PROBABLE THAT AN AIR LOCK HAS OCCURRED. TO CLEAR THE AIR LOCK, THE SELECTOR SHOULD BE TURNED TO THE WASH / RINSE MODE FOR ABOUT 5 SECONDS BEFORE RETURNING IT TO THE DRAIN POSITION.

# RINSING OPTION

IT IS POSSIBLE TO RINSE LAUNDRY BY ADDING CLEAN WATER TO THE SPIN TUB WHILE SPINNING

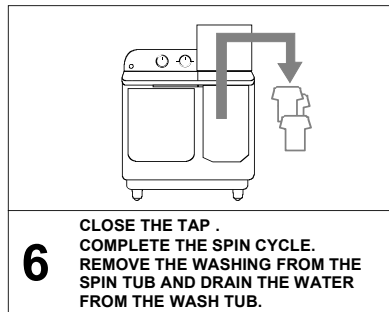
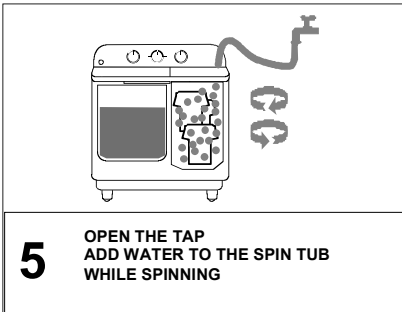
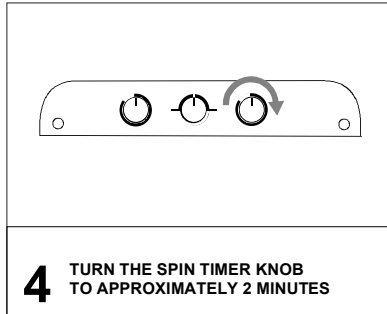
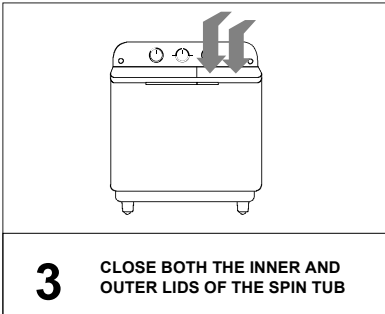
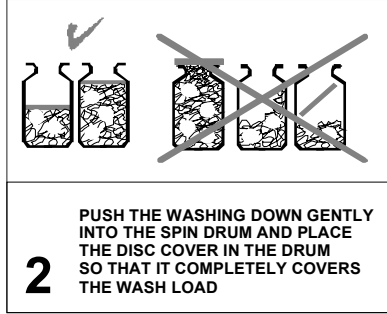

# SPIN DRYING



**1** PLACE THE WET WASHING IN THE SPIN DRUM, DISTRIBUTING IT EVENLY



**2** PUSH THE WASHING DOWN GENTLY INTO THE SPIN DRUM AND PLACE THE DISC COVER IN THE DRUM SO THAT IT COMPLETELY COVERS THE WASH LOAD

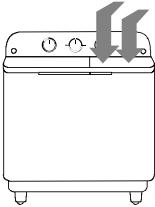

**3** CLOSE BOTH THE INNER AND OUTER LIDS OF THE SPIN TUB



**4** TURN THE SPIN TIMER KOB TO THE DESIRED SPIN TIME

RECOMMENDED SPIN TIMES		
FABRIC	TIME	MAX. DRY LOAD
SYNTHETICS, SILK WOOL,	1 min.	3.0kg
COTTON, LINEN	2 - 4 min.	4.0kg
VERY DIRTY WASHING	3 - 5 min.	4.0kg

**WARNING**

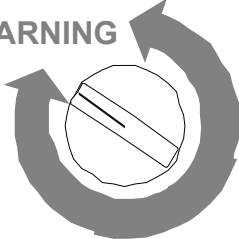

**IMPORTANT**  
NEVER TURN A KNOB FURTHER THAN THE MARKING ON THE DIAL  
TURN ANTI CLOCKWISE TO RETURN TO "0"

**NOTE: THE SPIN MOTOR MUST COOL DOWN FOR 20 MINUTES AFTER 4 CONSECUTIVE SPIN CYCLES.**

# AFTER USE

---

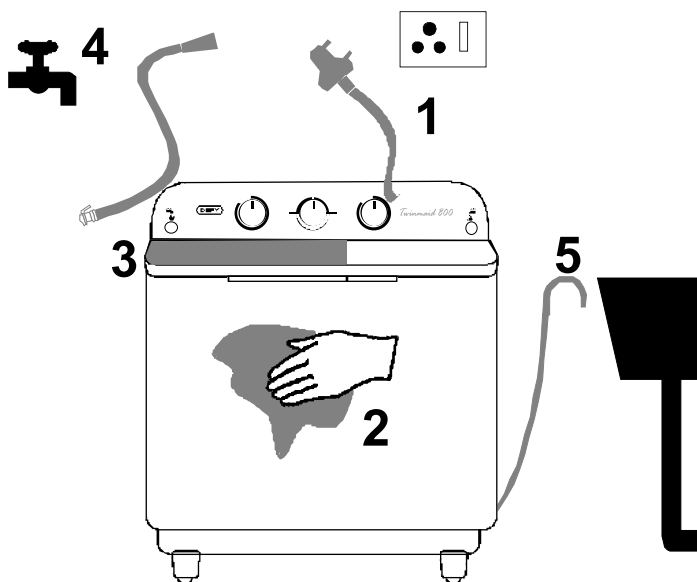

---

## NEVER TOUCH THE ELECTRICAL PLUG OR SOCKET WITH WET HANDS

- 1 SWITCH THE POWER OFF AT THE WALL SOCKET AND REMOVE THE PLUG FROM THE SOCKET.
- 2 DRY THE CABINET, THE CONTROL PANEL AND INSIDE THE TUBS WITH A SOFT, LINT FREE CLOTH.
- 3 PLACE THE WASH TUB LID IN POSITION OVER THE WASH TUB.
- 4 IF YOU WISH TO MOVE THE MACHINE, FIRST UNCOUPLE THE INLET HOSE FROM BOTH THE TAP AND THE MACHINE.
- 5 REMOVE THE OUTLET HOSE FROM THE DRAIN BUT DO NOT DETACH THE OUTLET HOSE FROM THE MACHINE.

# MAINTENANCE

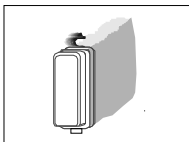

## CLEANING THE FILTER

**PERIODICALLY, THE FILTER BAG REQUIRES CLEANING. CAREFULLY PULL THE FILTER OUT. RINSE CLEAN UNDER RUNNING WATER AND REPLACE.**

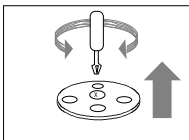

## BLOCKED PULSATOR

**HOLD THE PULSATOR AND LOOSEN THE PHILIPS SCREW  
LIFT OFF THE PULSATOR AND REMOVE THE BLOCKAGE.  
REPLACE THE PULSATOR, TIGHTEN THE SCREW AND  
REPLACE THE LID**

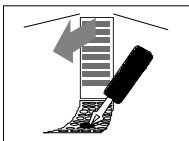

## BLOCKED DRAIN OUTLET

**PULL THE OVERFLOW COVER FORWARDS  
LOOSEN THE DRAIN VALVE COVER  
PULL THE DRAIN VALVE CONTROL LEVER UPWARDS  
CLEAN OUT ANY BLOCKAGES  
REPLACE THE DRAIN VALVE COVER AND OVERFLOW COVER**



## CLEANING THE CABINET

**WIPE THE CABINET WITH A DAMP SOAPY CLOTH.  
RINSE AND WIPE DRY.  
DO NOT USE HOUSEHOLD CLEANERS, ABRASIVES OR VOLATILE  
LIQUID CLEANERS**

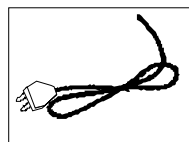

**IMPORTANT: IF THE POWER CORD SHOULD EVER NEED REPLACING,  
USE ONLY A GENUINE REPLACEMENT PART AVAILABLE FROM  
DEFY SERVICE CENTRES**

## Cleaning the drain filter

Regularly clean the drain filter located at the rear of the machine.

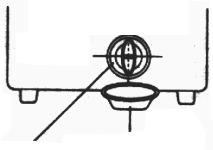

Place a shallow container under the drain-filter to collect any residual water spillage.

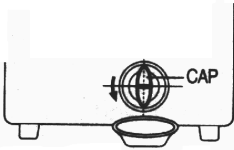

Turn the filter cap in an anticlockwise direction.

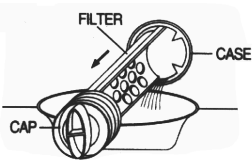

Pull the filter assembly out.

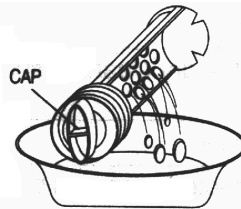

Clean the drain filter.

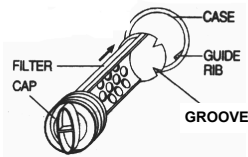

Re-fit the filter along the guides ensuring that the groove in the filter aligns with the guide rib.

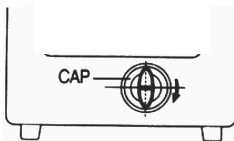

Tighten the cap by turning it in a clockwise direction.

# HELP

IF YOUR MACHINE WILL NOT WORK,  
CHECK THE FOLLOWING BEFORE CALLING A SERVICE TECHNICIAN

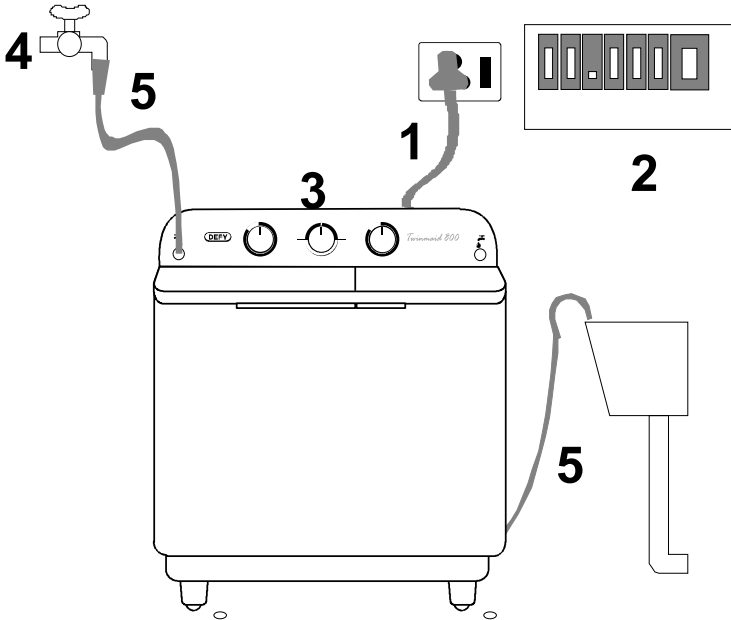

- 1 IS THE PLUG IN THE WALL SOCKET AND HAS THE POWER BEEN SWITCHED ON?
- 2 HAS A HOUSE FUSE BLOWN OR HAS A CIRCUIT BREAKER TRIPPED?
- 3 ARE THE CONTROL KNOBS IN THE CORRECT POSITION?
- 4 HAS THE WATER TAP BEEN TURNED OPEN?
- 5 HAS A HOSE BEEN KINKED, TWISTED OR BENT?
- 6 IS THE PULSATOR BLOCKED?
- 7 IS THE DRAIN OUTLET BLOCKED OR HAS AN AIR LOCK DEVELOPED see page 8
- 8 CHECK FOR CLOTHES ENTANGLED ROUND THE SPIN DRUM.
- 9 HAS THE SPIN TUB LID BEEN CLOSED PROPERLY?

IF YOU HAVE FOLLOWED THE INSTRUCTIONS AND STILL HAVE A PROBLEM,  
CONTACT THE NEAREST DEFY SERVICE CENTRE.  
THEY WILL BE ABLE TO HELP OR SEND A FACTORY TRAINED TECHNICIAN  
TO ASSIST YOU.



## SERVICE CENTRES

If you have followed the instructions and still have a problem, contact the nearest Defy Service Centre. They will be able to advise you on any aspect of the product or send a qualified technician to repair it.

### BLOEMFONTEIN

160 Long Street, Hilton, Bloemfontein 9301  
Tel: 051 400 3900  
[Bloemfontein.Service@defy.co.za](mailto:Bloemfontein.Service@defy.co.za)

### CAPE TOWN

5A Marconi Rd. Montague Gardens, 7441  
Tel: 021 526 3000  
[CapeTown.Service@defy.co.za](mailto:CapeTown.Service@defy.co.za)

### DURBAN

35 Intersite Avenue, Umgeni Business Park,  
Durban, 4051  
Tel: 031 268 3300  
[Durban.Service@defy.co.za](mailto:Durban.Service@defy.co.za)

### EAST LONDON

16 Bowls Rd. Arcadia, East London, 5201  
Tel: 043 743 7100  
[EastLondon.Service@defy.co.za](mailto:EastLondon.Service@defy.co.za)

### JOHANNESBURG

Cnr. Mimetes & Kruger Sts. Denver ext.12  
Johannesburg, 2094  
Tel: 011 621 0200 or 011 621 0300  
[Gauteng.Service@defy.co.za](mailto:Gauteng.Service@defy.co.za)

### POLOKWANE

87 Nelson Mandela Drive, Superbia 0699  
Tel: 0152 92 1166 / 7 / 8 / 9  
[Polokwane.Service@defy.co.za](mailto:Polokwane.Service@defy.co.za)

### PORT ELIZABETH

112 Patterson Road, North End, Port Elizabeth  
6001  
Tel: 041 401 6400  
[PortElizabeth.Service@defy.co.za](mailto:PortElizabeth.Service@defy.co.za)

### PRETORIA

Block A1 Old Mutual Industrial Park,  
Cnr. D.F.Malan Drive & Moot Str. Hermanstad,  
0082  
Tel: 012 377 8300  
[Pretoria.Service@defy.co.za](mailto:Pretoria.Service@defy.co.za)

### ZAMBIA: SOUTHGATE INVESTMENTS LTD

Plot 1606, Sheki Sheki Road  
P.O. Box 33681  
Lusaka, 10101, Zambia  
Tel: +260 0211 242332/3  
Fax: +260 0211 242933  
[sqiservicecentre@microlink.zm](mailto:sqiservicecentre@microlink.zm)

### NAMIBIA: ATLANTIC DISTRIBUTORS (PTY) LTD

10 Tienie Louw Street, Northern Industrial Area  
P.O. Box 21158, Windhoek, Namibia  
Tel: (061) 216162  
Fax: (061) 216134  
[atlantic@mweb.com.na](mailto:atlantic@mweb.com.na)

### ZIMBABWE: TRADECOMAFRICA

Trade Com Africa, 183 Loreley Crescent  
Msasa, Harare, Zimbabwe  
Tel: +263 4 486165/6  
Cell: +263 772 469010  
Cell: +263 772 469011

### BOTSWANA: RAY MORGAN AGENCIES

RMA Service Centre, Plot 48, East Gate  
Gaborone International Commerce Park  
Kgale View, Gaborone  
Botswana  
Tel: +267 390 3996 / 390 3912  
Fax: +267 318 7376  
Cell: +267 7134 6539  
[service@rma.co.bw](mailto:service@rma.co.bw); [raja@rma.co.bw](mailto:raja@rma.co.bw)

### SWAZILAND: LYND'S DISTRIBUTORS

P.O Box 716, Mbabane, Swaziland, H100  
Tel: (00268) 2515 4310/8  
Fax: (00268) 2518 4318

### MOZAMBIQUE: COOL WORLD. LDA

Rua da Resistencia No. 97B R/C  
Cell: +258 84 44 61 234  
[coolworldlda@hotmail.com](mailto:coolworldlda@hotmail.com)  
Nosso Show Room  
Av: da Industrias, Parcela No.735 \* 735A  
Machava, Maputo

**OTHER AREAS ARE SERVICED BY OVER 200 AUTHORISED SERVICE AGENTS.  
PLEASE CONSULT THE NEAREST REGIONAL DEFY SERVICE CENTRE FOR DETAILS**

# Warranty

This certificate is issued by DEFY APPLIANCES LIMITED manufacturers of Defy and Ocean products, hereinafter the Company, to the original purchaser only, of the appliance described on the certificate and shall constitute the only warranty given in respect of this appliance.

The Company warrants to the original purchaser that for a period of **TWO YEARS** from date of purchase the appliance is free from defect under normal domestic use, both in workmanship and material, subject to the following conditions.

1. Repair or replacement of any part of this appliance, found by the Company to be defective, shall be at the election of the Company. The Company reserves the right to effect such service through any of its Service Divisions or Authorised Service Dealers. The cost of such service shall be borne by the Company in full, provided that the appliance is located no further than 50 km. from a Company Service Centre or an Authorised Service Dealer. Where the appliance is located beyond the 50 km. radius, the purchaser shall be liable for the standard travelling charges, as determined by the Company.

CARRY IN SERVICE Microwave ovens, Compact cookers and small appliances are repaired in our service centres and are not collected from the customers home. Faulty units should be delivered to the purchasing dealer or to the nearest Company Service Centre for warranty repairs.

2. Vitreous enamelware, fuses and lamps are specifically excluded from these warranties. It is an express condition of these warranties that the purchaser takes due care and attention in the use and maintenance of the appliance. Abuse, misuse in conflict with operating instructions, connection to incorrect voltages and subjection to commercial use shall release the Company from its obligations.

3. This warranty shall become void and cease to operate if the appliance is dismantled by, or any repairs to the appliance are effected by any persons not duly authorised by the Company, or if substitute parts not approved by the Company are used in the appliance, or if the serial number of the appliance is removed.

4. The Company shall not be responsible for damages resulting from fire, flood, civil disturbances or any Act of God. The Company shall not, in terms of these warranties be responsible nor held liable for any consequential loss or damage of any kind caused by or due to the failure or malfunction of the appliance.

5. The Company shall not be responsible for transportation or other costs other than those incurred within the provisions of Point 1 of this Certificate.

6. These warranties shall not apply to the appliance if it is purchased or used beyond the borders of the Republic of South Africa, Namibia, Botswana, Swaziland and Lesotho.

7. Where service is requested under warranty and no fault or defect can be found by the Company, all costs incurred will be for the purchaser's account.

8. This Certificate as well as your invoice will serve as proof of purchase. For the purpose of warranty, it will be essential to produce this Certificate and invoice. Failure to do so, will render the purchaser liable for service costs.

**KEEP THIS CERTIFICATE AND SALES INVOICE AS PROOF OF  
PURCHASE FOR WARRANTY PURPOSES.**

## Circuit diagram

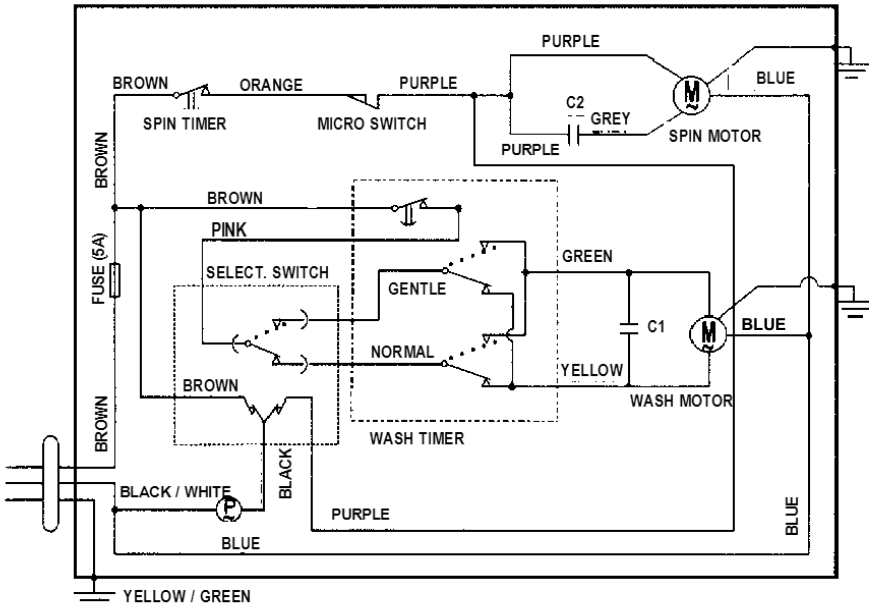

**NOTE**

C1: 10uF AC450V 50 Hz

C2: 5uF AC450V 50 Hz

## Specifications

<b>POWER SOURCE:</b>	AC 230 V
<b>FREQUENCY:</b>	50Hz
<b>POWER CONSUMPTION:</b>	WASH MOTOR - 280W SPINDRYER MOTOR - 180W PUMP - 30W
<b>EXTERNAL DIMENSIONS:</b>	HEIGHT 991mm WIDTH 819mm DEPTH 482mm
<b>NETT WEIGHT:</b>	25 Kg
<b>WATER CAPACITY:</b>	High 60 litres Med. 54 litres Low 48 litres

The Manufacturer strives for continuous improvements. The content of this book is therefore subject to change without notice.

Please read these instructions carefully before installing and operating the washing machine  
Record in the space below the listed information for future reference. The Serial number may be found on the back of the machine

SERIAL No.....

DATE OF PURCHASE.....

PURCHASED FROM.....